

BRAND NEW INDOOR

GAME TABLES





OSKAR

Foosball Table

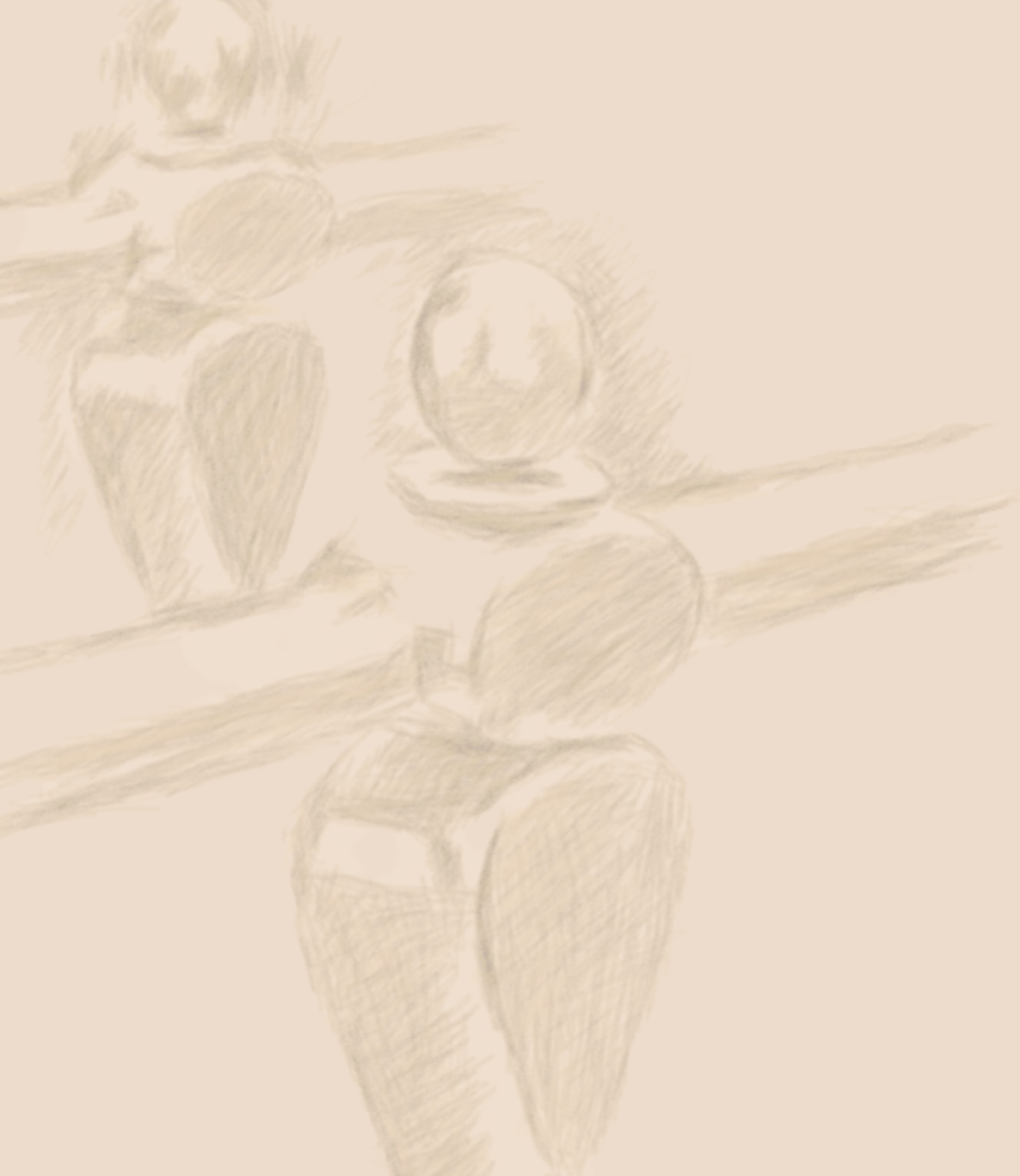

Rounded shapes, sinuous lines and pastel colours. The inspiration for the new Oskar Foosball Table comes directly from the 50s design.

Its soft shape marries perfectly with the little players, inspired by the theatrical figures of the Bauhaus master Oskar Schlemmer.

The playful spirit of this table is in perfect harmony with its design.





Rounded shapes,
sinuous lines and
pastel colours.



Technicals

Oskar Foosball Table

Designed by Bellavista & Piccini

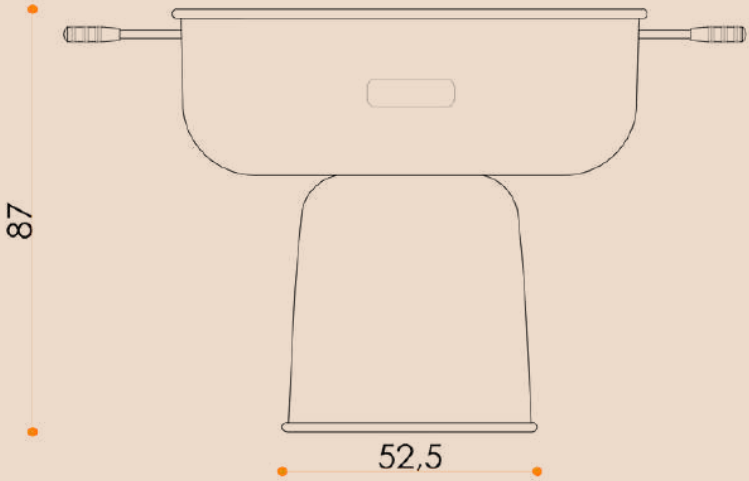
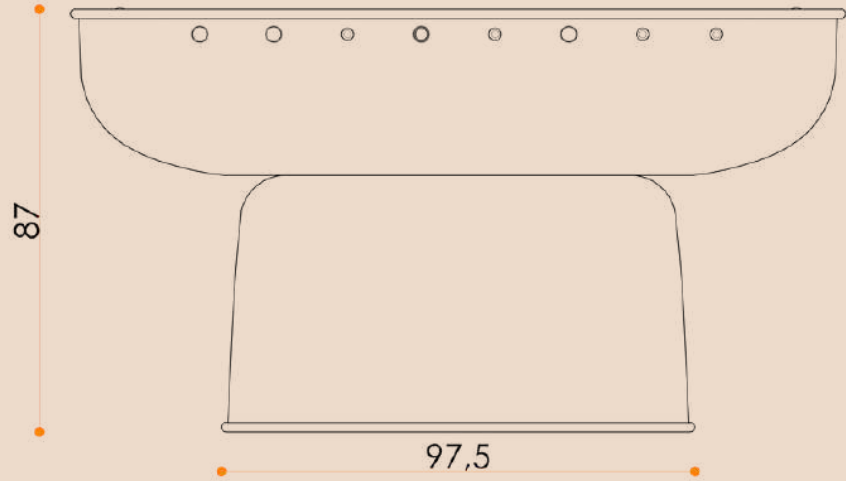
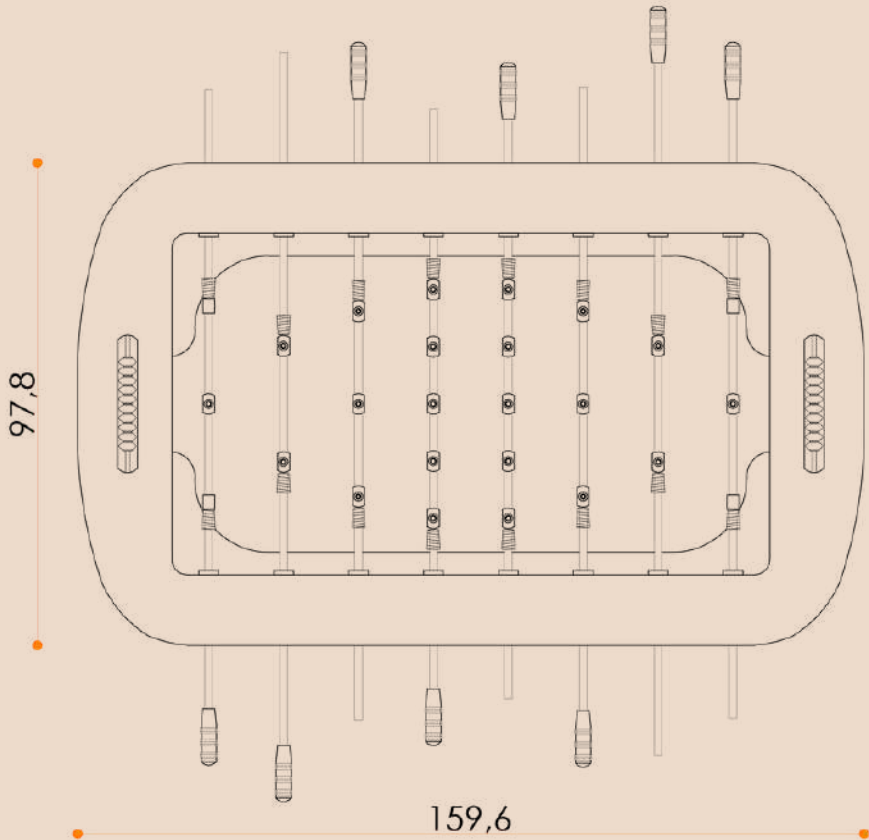

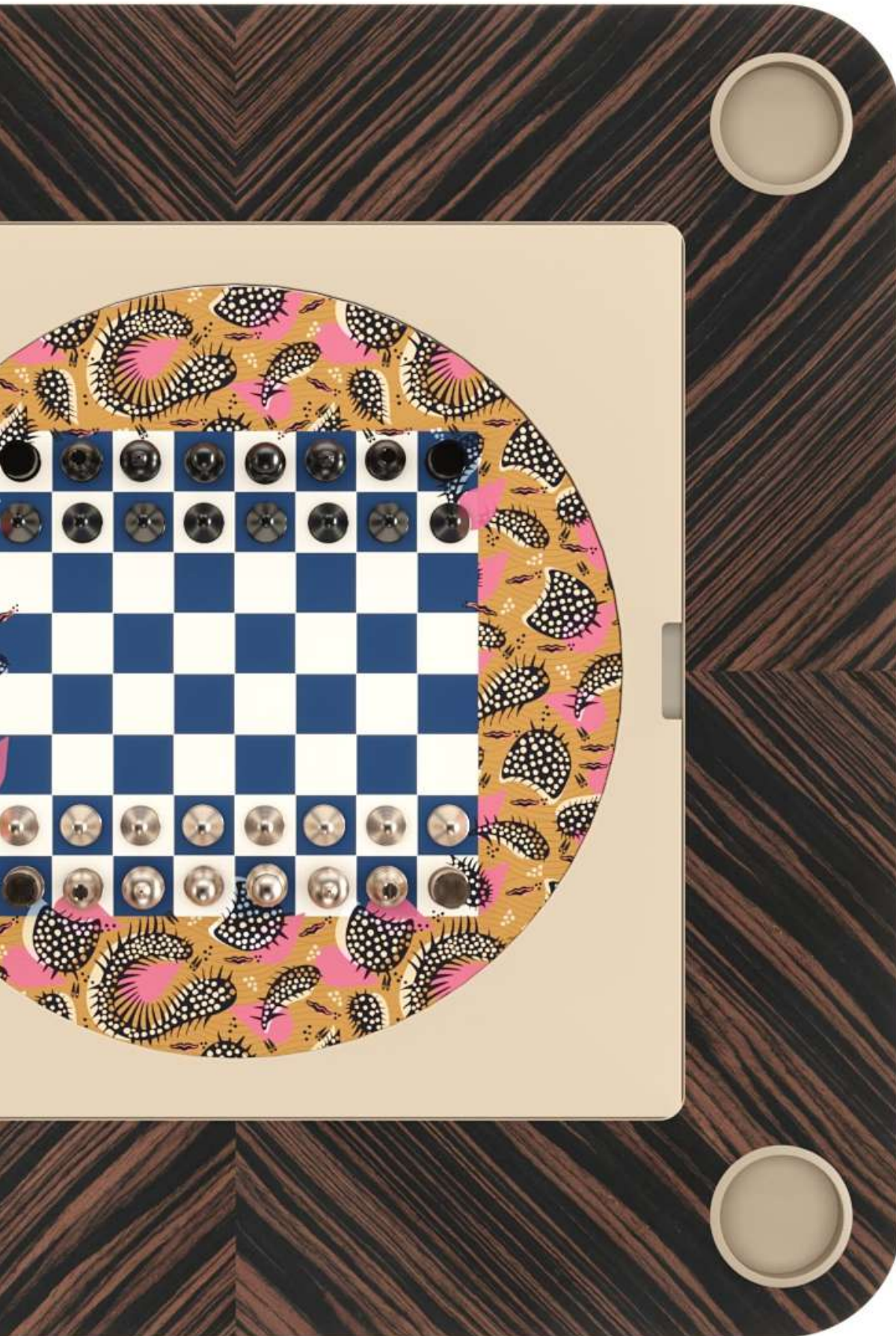

ENIGMA

Multigame Table

An apparently simple table hides secrets ready to be revealed.
A product that changes, but always remains the same.
Enigma is a multi-game table that thanks to interchangeable tops allows you to have your favourite games close at hand, in a single product.





A product that
changes, but always
remains the same.

ENIGMA

Cards, Domino, Mahjong Edition



ENIGMA

Carrom Edition



ENIGMA

Cards, Domino, Mahjong Edition



Add your additional
games

Double Face Chess & Backgammon Board



ENIGMA

Carrom Edition

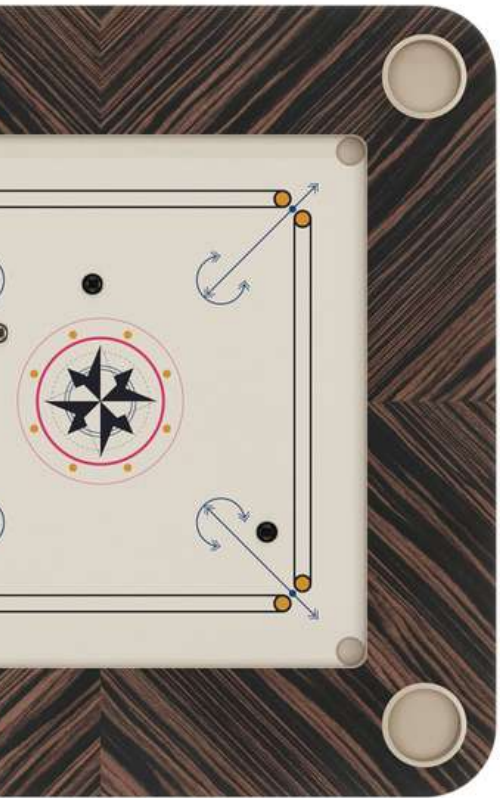

Choose your
additional games

Double Face Chess & Cards Board

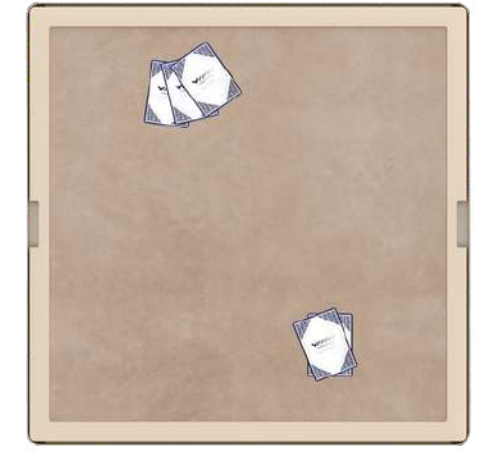

Double Face Backgammon Board & Cards Board

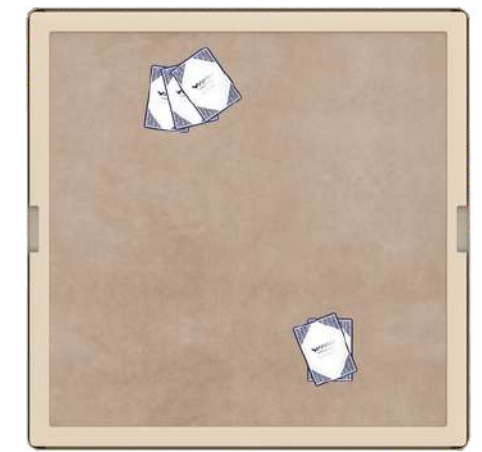

Double Face Chess & Backgammon Board



The background features a light beige color with a collage of various game accessories. At the top, there are several playing cards: a diamond, a spade, a club, and a heart. Below these are two dice, one showing a 1 and the other a 6. In the center, there is a large chess king piece. At the bottom, there are more playing cards, including a spade, a club, a diamond, and a heart. There are also several chess pieces: a knight, a rook, and a king. The text "Four drawers hide all game accessories needed." is centered in a dark brown, serif font.

Four drawers hide all
game accessories
needed.

Technicals

Enigma Multigame Table

Designed by Alberto Biagini

